

Distributed by
Raymarine

Any reference to Raytheon or RTN in this manual should be interpreted as Raymarine. The names Raytheon and RTN are owned by the Raytheon Company.

Autohelm[®]

ST 30

COMPASS
Operation and
Installation

Autohelm[®]

A **Raytheon** Company

Raytheon Marine Europe, Anchorage Park, Portsmouth
PO3 5TD, England
Telephone (01705) 693611. Fax (01705) 694642

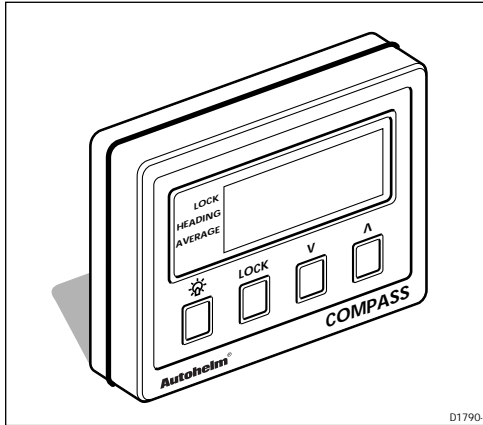

Autohelm and SeaTalk are registered Trade marks of Nautech Limited

The technical and graphical information contained in this handbook, to the best of our knowledge, was correct as it went to press. However, the Autohelm policy of continuous improvement and updating may change product specifications without prior notice. Therefore, unavoidable differences between the product and handbook may occur from time to time, for which liability cannot be accepted by Autohelm.

Copyright Raytheon Marine Europe 1995

Package Contents

Checking your ST30 Compass Package

The ST30 Compass package contains the following standard items:

1. Display head
2. Fixing studs (2)
3. Thumb nuts (2)
4. Fitting template
5. Sun cover
6. Fluxgate compass
7. Power cable
8. Daisy-chain cable
9. Self-tapping screws (4)
10. Installation and Operation handbook
11. Worldwide Service Centre booklet
12. Warranty document

Items Missing?

If any of the above items are missing or damaged, please contact your Autohelm dealer or our Product Support Department to obtain replacement parts. **Please note that missing or damaged items cannot be replaced without proof of purchase.**

Registering this Product

Once you have checked that you have all of the listed components, please take the time to complete the warranty document and return it to your national distributor.

By returning this document you will receive prompt and expert attention should you ever experience any difficulties with this product. Also, your details are added to our customer database so that you automatically receive new product brochures as and when they are released.

Package Items

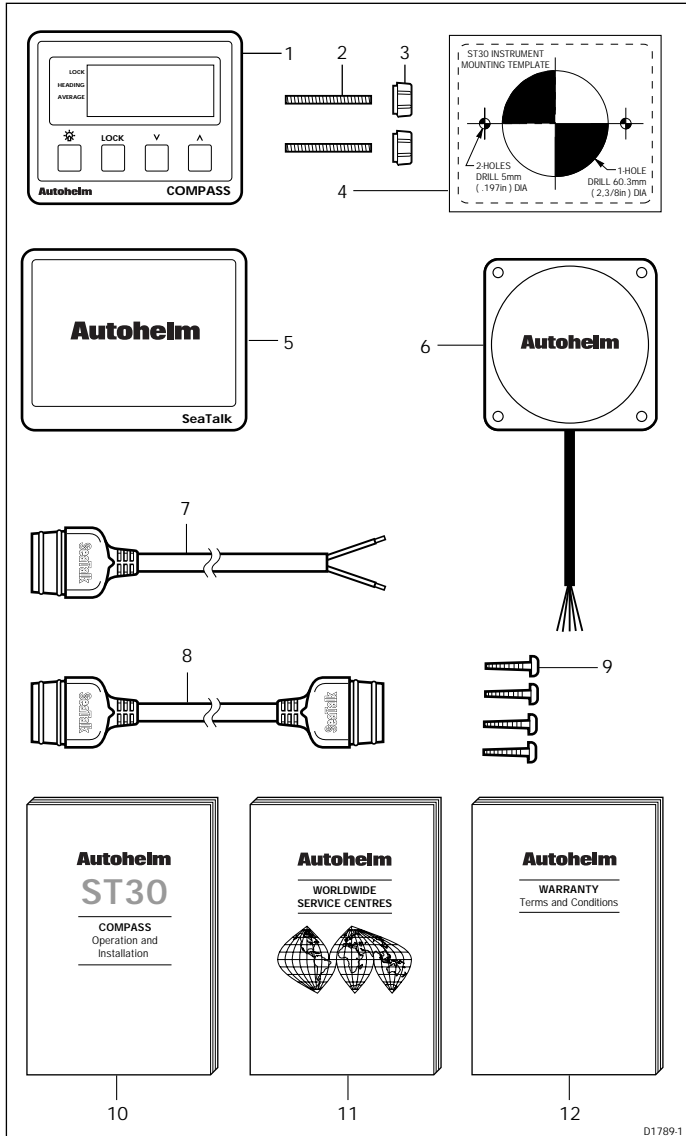

Contents

Chapter 1: Introduction	7
Chapter 2: Installation	9
2.1 Compass Installation Options	9
2.1 Installing the Fluxgate Compass	10
2.2 Siting of the Display Head	12
2.3 Mounting the Display Head	13
2.4 Flush Mounting the Display Head	14
2.5 Trunnion Mounting the Display Head	15
2.6 Power supply (Stand-alone operation)	15
2.7 Power supply & Data Transfer (SeaTalk system)	16
Chapter 3: Calibration	17
3.1 About this Chapter	17
3.2 User Calibration	17
Manual Compass Linearisation	17
Heading Alignment	19
Quitting Manual Linearisation & Heading Alignment	19
3.3 Linearisation & Heading Alignment when used with a SportPilot	20
3.4 Extended Calibration	20
Calibration ON/OFF	21
Boat Show Mode	22
Heading Display Damping	22
Off-Course Bargraph Damping	23
Quitting Extended Calibration	23
Quitting without Saving	23
Quitting and Saving	23
3.4 Master and Repeater Modes	23
3.5 Software Version	24

Chapter 4: Operation	25
4.1 General	25
4.2 Heading Mode	25
4.3 Lock Mode	26
Reciprocal Locked Heading	26
Adjusting the Locked Heading	27
Lock Mode Heading Error	27
4.3 Average Heading	28
Resetting the Average Heading	28
4.4 LCD Illumination	29
4.5 No Data	29
Chapter 5: Fault Isolation & Maintenance	31
5.1 Fault Isolation	31
5.2 Maintenance	32
Chapter 6: Specification	33

Chapter 1: Introduction

Congratulations on the purchase of your Autohelm ST30 Compass.

The compass displays heading information directly from the fluxgate compass or, if the unit is used as a repeater, via the SeaTalk bus using data taken from another compass instrument or autopilot.

The compass can also be used as a steering indicator to maintain a given course. Any helmsmans error, to port or starboard, is indicated by a bargraph at the bottom of the display. This mode is known as "Lock" mode.

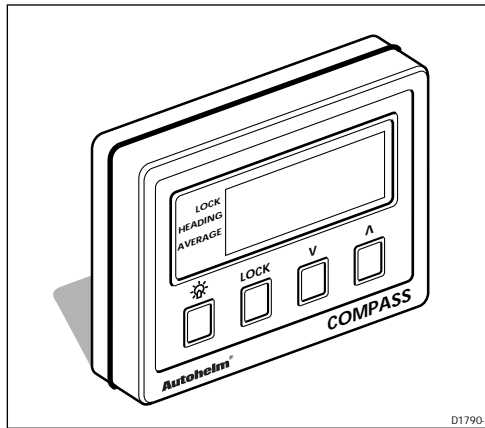

Important Information

All Autohelm equipment and accessories are designed to the highest standard for use in the leisure marine environment.

Their design and manufacture conforms to the latest Electromagnetic Compatibility (EMC) standards, but good installation is required to ensure that performance is not compromised. Although every effort has been taken to ensure that they will perform under all conditions, it is important to understand what factors could affect the operation of the product. To avoid the risk of EMC problems, all Autohelm equipment and cables connected to it should be;

- ❑ At least 1m (3 feet) from any equipment transmitting or cables carrying radio signals e.g. VHF radios, cables and antennas. In the case of SSB radios, the distance should be increased to 2m (7ft).
- ❑ At least 20m (66 feet) from large vessels equipped with radar.
- ❑ More than 2m (7 feet) from the direct path of a radar beam.

The following points should also be noted;

- ❑ Genuine Autohelm cables should be used at all times. Cutting and rejoining these cables can compromise EMC performance and so should be avoided unless doing so is detailed in the installation manual.
- ❑ Autohelm equipment should be serviced only by authorised Autohelm service engineers. They will ensure that service procedures and replacement parts used will not affect EMC performance. There are no user serviceable parts in any Autohelm product.
- ❑ Voltage drops below 10v in the power supply to our products can cause the equipment to reset. This will not damage the equipment but will cause the loss of some information and can change the operating mode. This most frequently happens during engine starting, and so to reduce the risk of this occurring, it is recommended that the equipment is supplied from a different battery than the one used for engine start.
- ❑ Some products generate high voltages, and so never handle the cables/connectors when power is being supplied to the equipment.
- ❑ Always check the installation before going to sea to make sure that it is not affected by radio transmissions, engine starting etc.
- ❑ In some installations, it may not be possible to prevent the equipment from being affected by external influences. In general this will not damage the equipment but can lead to it resetting, or momentarily result in faulty operation.

Please keep these notes for future reference.

Chapter 2: Installation

This chapter covers installation of the fluxgate compass and the display head. Please read these instructions thoroughly before you attempt to install the display head and fluxgate compass.

2.1 Compass Installation Options

The ST30 Compass can be used in one of the following ways:

- as a stand alone system comprising of display head and fluxgate compass with an independent power supply. Heading data is sent directly to the compass display head.

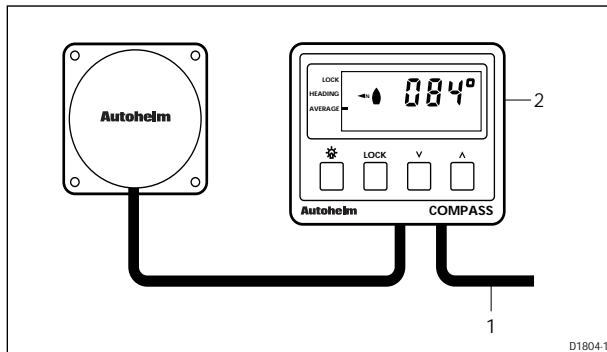

Stand alone compass system: **1** Master compass instrument **2** Power cable

- as a repeater head for a master compass instrument. Power and data is received via SeaTalk.

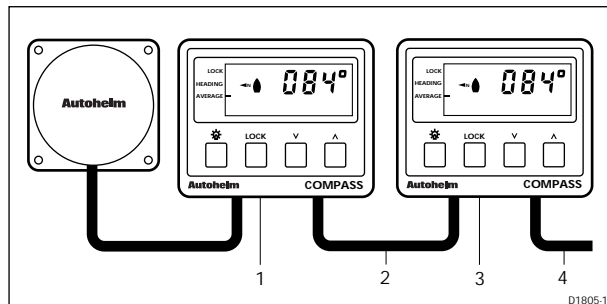

Master with repeater instrument: **1** Master instrument **2** SeaTalk daisy-chain cable
3 Repeater instrument **4** Power cable or SeaTalk cable

- ❑ as a repeater for an autopilot compass. Power and data is received via SeaTalk.

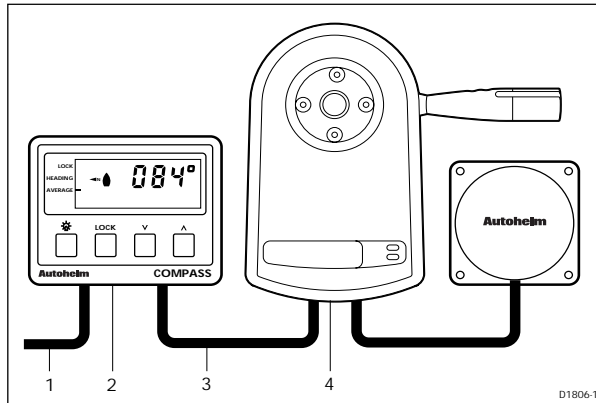

ST30 Compass & autopilot: 1 SeaTalk cable 2 Repeater instrument 3 SeaTalk cable 4 SeaTalk autopilot

Important note...

When the ST30 Compass is used with a SportPilot the fluxgate compass must be connected to the SportPilot and not the display head.

2.1 Installing the Fluxgate Compass

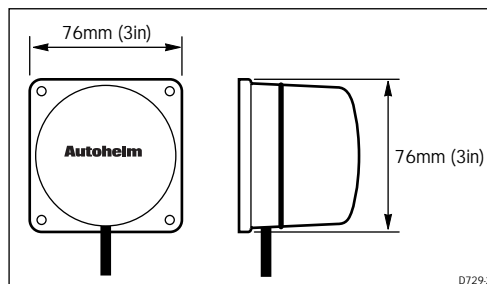

The fluxgate compass should, ideally, be sited on a forward facing bulkhead with the Autohelm logo facing forwards. The compass should also be as close to the pitch and roll centre of the vessel as possible and sited (at least 0.8m) away from iron masses that cause deviation.

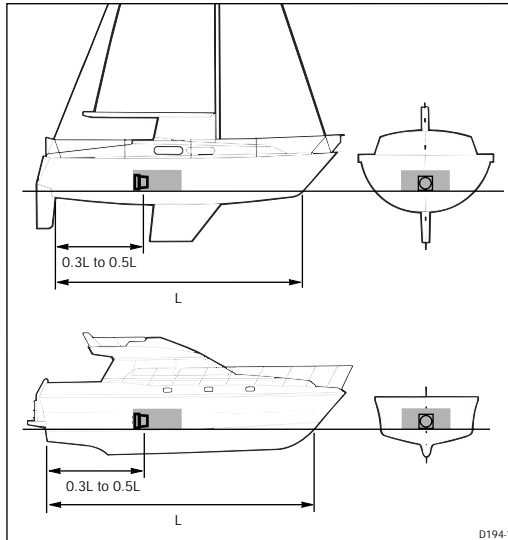

1. With a hand bearing compass fixed to the proposed bulkhead, turn your vessel through 360° and check that the difference between the hand bearing compass and the ships compass does not exceed 10° on any heading. If difference does exceed 10° you will have to select a new location.
2. Once you have selected a suitable location, attach the fluxgate compass to the bulkhead using the four self-tapping screws provided.
3. Make sure that the fluxgate compass is correctly orientated. That is, the arrow and the word UP embossed into the compass flange is pointing skywards and the top of the flange is level - *the fluxgate compass will not operate if it is installed incorrectly.*

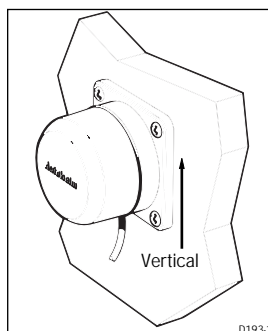

3. Run the cable back to the display head, fixing the cable at regular intervals with cable clamps/ties.
4. Crimp the spade connectors to the five wires from the compass cable.

2.2 Siting of the Display Head

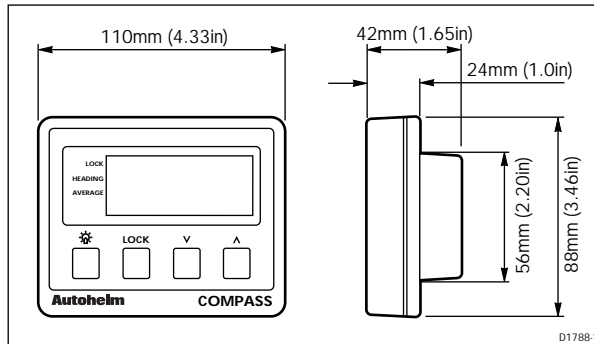

The ST30 Compass should be installed above or below deck where it is:

- easily read by the helmsman (normally viewed at eye level)
- protected from physical damage
- at least 230mm (9in) from the ships compass
- at least 500mm (20in) from radio receiving equipment
- accessible from behind for ease of installation and cable running

Notes...

To prevent the build-up of moisture, the display head breathes through the back cover. The display head must, therefore, be mounted where the back cover is protected from direct contact with water.

The rear case is fitted with a foam gasket to form a water-tight seal between the display head and the installation bulkhead. Under no circumstances must silicone sealants be applied to this gasket.

2.3 Mounting the Display Head

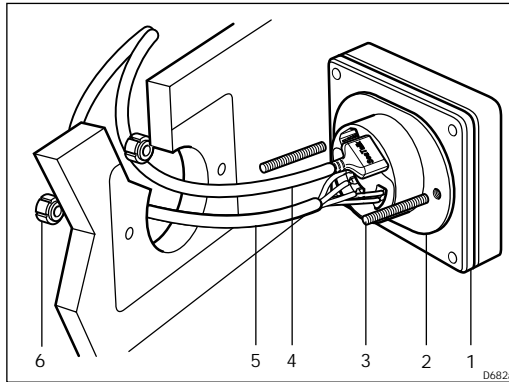

1 Display head **2** Sealing gasket **3** Fixing studs **4** SeaTalk or power cable
5 Fluxgate compass cable **6** Thumb nuts

1. Make sure the bulkhead to which the display head (1) is to be mounted is smooth, flat, and clean.
2. Use the fitting template (supplied) to mark the centres for the two fixing studs and the display head cable boss.

Please note...

To allow for the fitting of protective covers, adjacent instruments must have a 6mm (1/4in) gap between them (116mm centre to centre min.).

3. Drill two 5mm (0.2in) diameter holes for the fixing studs (2).
4. Using a 60mm (2.375in) diameter cutter, drill a location hole for the instrument connector boss.
5. Plug the moulded end of the power cable in to one of the SeaTalk terminals.

- Connect the fluxgate compass cables, colour for colour, to the display head (1) compass terminals (the black core goes to the grey terminal).

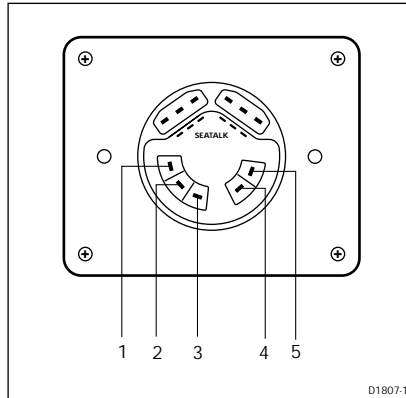

Fluxgate compass to display head connections: **1** Red cable **2** Black cable **3** Blue **4** Green **5** Yellow

- Attach the display head to the bulkhead using the fixing studs (2) and thumb nuts (3).

2.4 Flush Mounting the Display Head

The ST30 Compass display head can be flush mounted to provide a “low profile” installation. Full installation procedures are supplied with the flush mounting kit (part number D217).

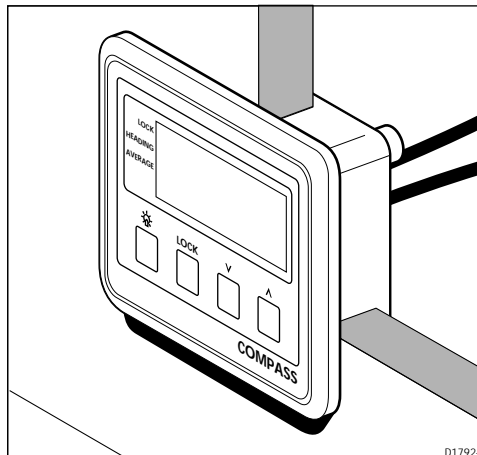

2.5 Trunnion Mounting the Display Head

The display head may also be trunnion mounted using the custom Autohelm mounting kit (part number D219).

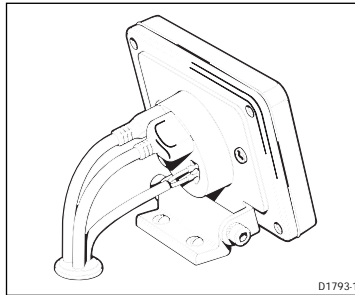

Note...

Because the ST30 Compass breathes around the integral connector pins, trunnion mounted instruments must be sited in areas protected from the weather and direct contact with water.

2.6 Power supply (Stand-alone operation)

Caution: The ST30 Compass is for use with 12V supplies only.

For stand-alone operation, use the supplied 1m power cable supplied.

1. Plug the moulded end of the power cable into to one of the 'SeaTalk' connections in the rear of the display head. Run the free end back to the vessels distribution panel.
2. Cut the cable to length and connect the red wire to 12V and the screen to 0V. Protect the circuit with a 5A fuse/circuit breaker.

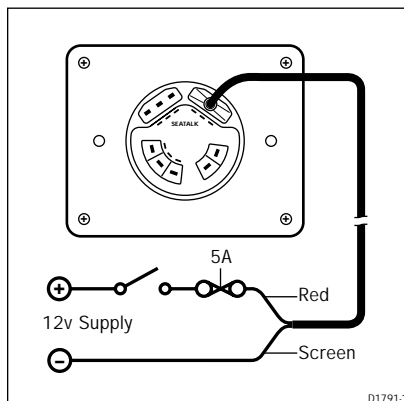

2.7 Power supply & Data Transfer (SeaTalk system)

When the ST30 Compass is part of a SeaTalk system, power and data is transmitted via the daisy-chain cable or one of the Standard Autohelm SeaTalk Extension or Interface Cables.

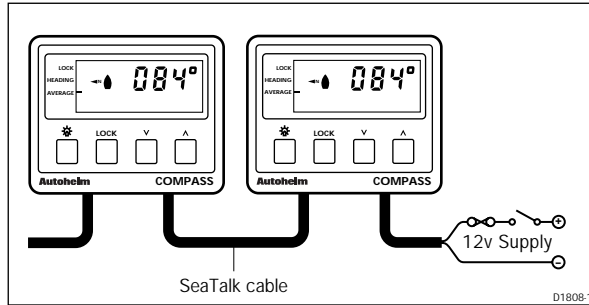

Chapter 3: Calibration

3.1 About this Chapter

Before the ST30 Compass system can be used as a navigational aid, the fluxgate compass **MUST** be linearised to compensate for deviation and the displayed heading **MUST** be aligned to a known transit bearing.

Other calibration features allow you to adjust the speed at which the heading and heading error displays are updated.

3.2 User Calibration

User calibration contains features to perform compass linearisation and heading alignment.

Manual Compass Linearisation

For first-time installation, the fluxgate compass must be manually linearised to compensate for deviation.

1. Press  and LOCK together for 2 seconds to open the initial calibration menu.

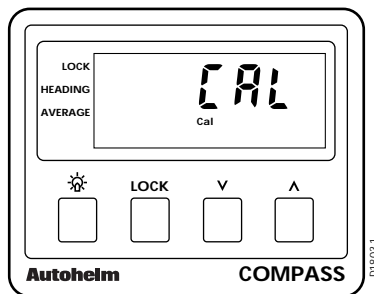

- Press **LOCK** to advance to the manual linearisation display. The magnetic North indicators rotate to indicate that you are in linearisation mode.

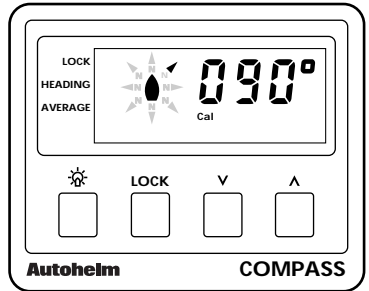

- With a boat speed around 2 knots, start turning your vessel in a very slow circle.

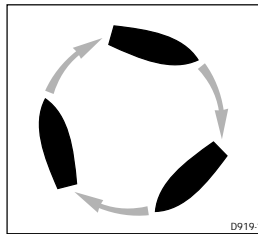

Please note...

If you turn your vessel too quickly the display changes to read SLO and the buzzer sounds.

- Keeping turning your vessel until the display begins to alternate between the heading and deviation displays and the magnetic North indicators stop rotating.

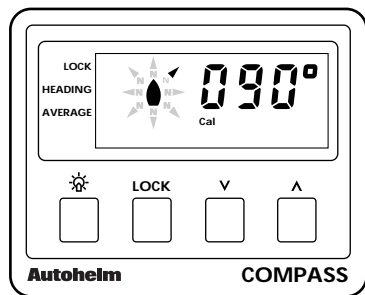

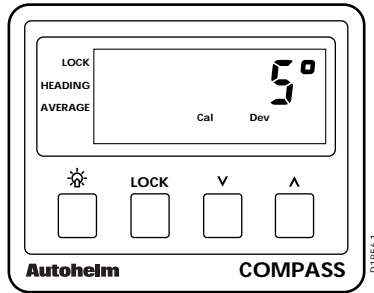

Please note...

If the deviation exceeds 10° the fluxgate compass should be resited.

Heading Alignment

Once the compass has been successfully linearised, you must match the displayed heading to a known transit bearing.

1. From the compass deviation display, simply press **^** or **V** to advance to heading alignment.
2. Press the **^** or **V** key to adjust the displayed heading to match the known transit bearing.

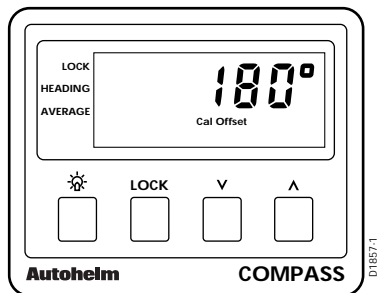

Quitting Manual Linearisation and Heading Alignment

To quit manual linearisation and/or heading alignment and return to normal compass operation, simply press **☀** and **LOCK** for 2 seconds.

Quitting without storing changes!

You can quit Manual Linearisation and Heading Alignment without storing any adjustments by simply pressing **☀**.

3.3 Linearisation and Heading Alignment when used with a SportPilot

Because the Autohelm SportPilot does not have a digital read-out, the ST30 Compass can be used to repeat heading information received from SportPilot fluxgate compass.

To display accurate heading information, the SportPilot fluxgate compass must be linearised and then aligned to a known transit bearing as described in section 3.2.

Please note...

When the ST30 Compass is used with a SportPilot system, the SportPilot must have a fluxgate compass connected to it.

3. 4 Extended Calibration

Extended calibration contains features to:

- restrict access to the user calibration menu
 - start the dealer demonstration programme
 - adjust the heading display damping
 - adjust the off-course bargraph damping
1. At the heading or locked heading display, press and hold  and **LOCK** for 15 seconds. After 15 seconds the compass display displays "CAL".

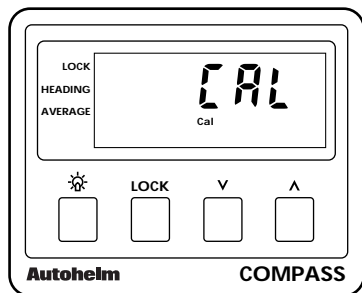

2. Press **▲** and **▼** momentarily to enter extended calibration.

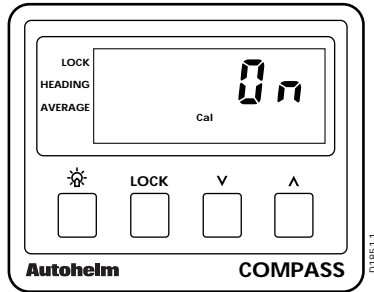

Calibration ON/OFF

This feature is used to restrict access to the user calibration menu to prevent accidental adjustment of the linearisation and heading alignment features.

Calibration is toggled on and off by pressing the **▲** or **▼** key.

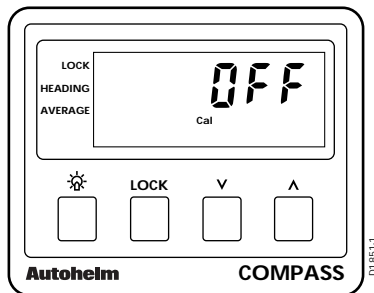
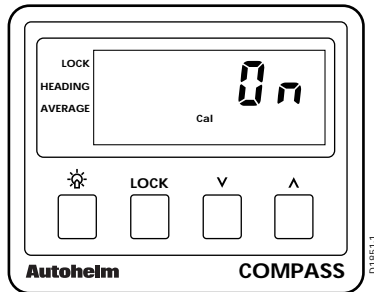

Press **LOCK** to advance to "Boat Show" mode or exit extended calibration as described on page 23.

Boat Show Mode

This is a programme that simulates heading information for dealer demonstration purposes.

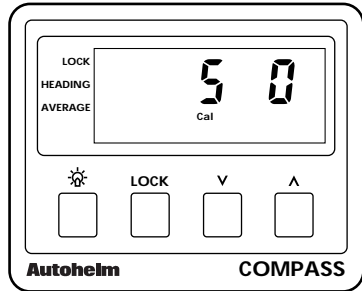

Boat show mode is toggled on (S1) and off (S0) using the **^** or **V** key.

Press **LOCK** to advance to "Heading Display Damping" or exit extended calibration as described on page 23.

Heading Display Damping

The heading displayed by the ST30 Compass is the average reading taken from the fluxgate compass. Damping controls the number of readings used in each averaging calculation. The higher the value displayed at the damping display the slower the screen update of heading information.

The default value is d4 which can, if so required, be adjusted using the **^** or **V** key.

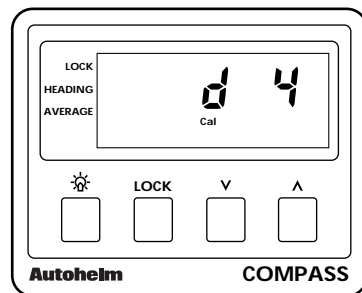

Press **LOCK** to advance to " Off-Course Bargraph Damping" or exit extended calibration as described on page 23.

Off-Course Bargraph Damping

This feature controls the rate at which the off-course bargraph is updated. The factory default setting is 4 which can, if so required, be adjusted using the **▲** or **▼** key. The higher the value displayed the slower the screen update of the bargraph.

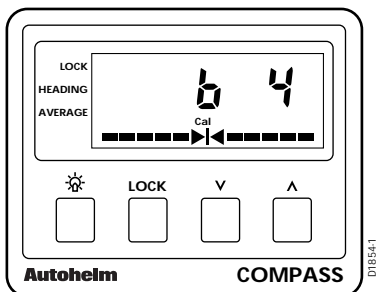

Press **LOCK** to advance to " Calibration ON/OFF" or exit extended calibration as described below.

Quitting Extended Calibration

You can quit extended calibration and return to normal operation in one of two ways:

Quitting without Saving

To quit extended calibration without saving, simply press **☼** momentarily.

Quitting and Saving

To quit extended calibration and save any changes made to the extended calibration features, simply press and hold **☼** and **LOCK** together for 2 seconds.

3.4 Master and Repeater Modes

As described in the installation chapter, the ST30 Compass can be used as a master or repeater instrument. The selection of these modes is performed automatically with no input required from the user.

3.5 Software Version

During the key sequence to advance to extended calibration, the software version is displayed. This can also be accessed by pressing  and **LOCK** for 4 seconds.

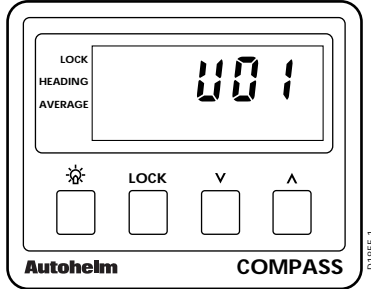

The compass will return to normal operation after 8 seconds.

Chapter 4: Operation

4.1 General

This chapter describes the operational features of the ST30 Compass using sample displays and text references.

Points to remember...

All key presses are confirmed by a single beep. This audible confirmation cannot be turned off.

The ST30 Compass cannot receive or transmit NMEA data directly.

If linearisation has not been carried out, the small CAL legend flashes for 1 minute every time the ST30 Compass is powered up. The accuracy of the heading display cannot be guaranteed until linearisation has been completed.

4.2 Heading Mode

This is the default mode of operation and is always displayed in degrees magnetic. North, relative to your compass heading, is displayed as a graphic to the left of the heading.

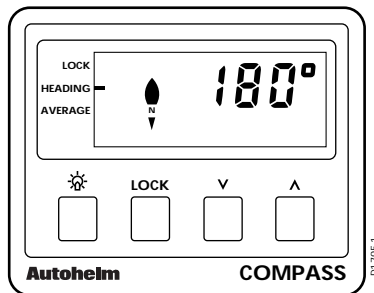

4.3 Lock Mode

This mode allows you to lock onto a heading and then steer your vessel using the off-course bargraph to maintain the locked heading, which is stored as the datum as soon as you engage lock mode.

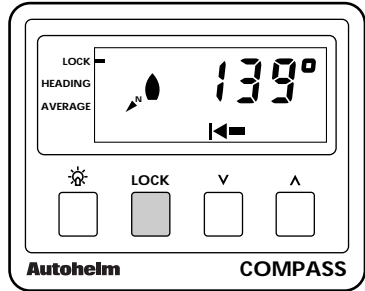

The off-course bargraph consists of 5 port and 5 starboard segments plus the arrow head, which indicates a course error of 2°. The 5 segments indicate course errors of 4°, 7°, 11°, 16°, and 22°.

Auto Lock

If AUTO is engaged from an Autohelm autopilot, the pilot will override the ST30 compass locked heading. The small "AUTO" legend is displayed during this mode to indicate that AUTOLOCK has been engaged.

Reciprocal Locked Heading

If your course error exceeds +/- 110° the compass automatically selects the reciprocal locked heading.

Please note...

If the ST30 Compass is being used with an autopilot, the reciprocal heading feature is disabled.

Adjusting the Locked Heading

The locked heading can be adjusted at any time by simply pressing the **▲** and **▼** key to increase or decrease the displayed heading.

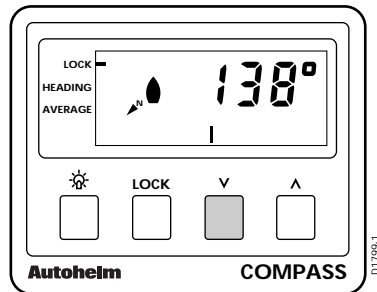
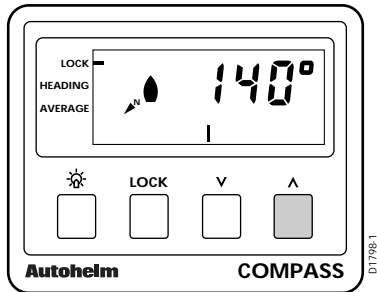

Lock Mode Heading Error

When you exit lock mode, the average heading error during lock mode operation is displayed for 8 seconds.

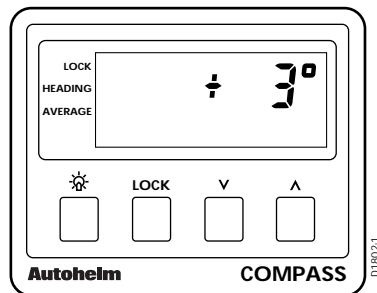

4.3 Average Heading

The compass continuously calculates the average course steered. This is independent of whether the compass is in Lock mode.

To display the average course, simply press **▲** and **▼** together momentarily.

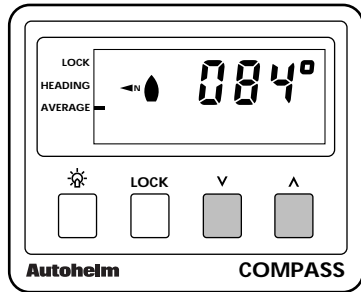

The average course is displayed for 8 seconds at which time the display reverts to the lock display.

Resetting the Average Heading

With the average heading displayed, simply press and hold **▲** and **▼** together for 3 full seconds to reset the average (the compass beeps once to indicate that the average heading is being reset).

Please note...

After 24 hours of continuous operation, the compass will stop calculating the average heading and the display will flash.

4.4 LCD Illumination

The ST30 Compass has four illumination settings: high (L3), medium (L2), low (L1), and off (L0). The LCD is illuminated by simply pressing the  key. This key is also used to cycle the illumination settings.

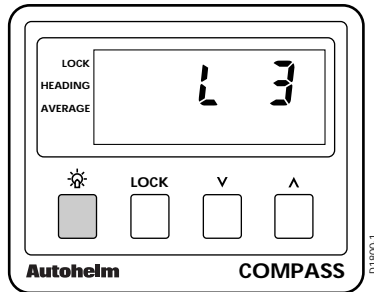

If the ST30 Compass is on the SeaTalk bus, the illumination can be adjusted from any instrument. Likewise if the illumination is adjusted from the compass the illumination of all the instruments on the bus will be altered.

Please Note...

The compass returns to normal operation 8 seconds after the last key press

4.5 No Data

If the compass fails to receive compass information, or if the transducer is not connected when the compass is the sole compass unit on the bus, the display will consist of just dashes.

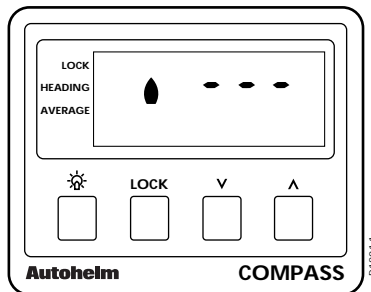

Chapter 5: Fault Isolation & Maintenance

5.1 Fault Isolation

In the unlikely event that a fault occurs with your ST30 Compass, the following table should help you identify the most likely cause and provides the action required to correct a fault.

Fault	Cause	Action
Compass display is blank.	No power supply	Check the cables are plugged in and are secure.
		Check the fuse/circuit breaker.
Displayed heading is different from the ships compass.	Deviation present.	Carry out the compass linearisation procedure.
	Ships compass is incorrect.	If your boat has dual steering compass stations, make sure that both compasses are displaying the same heading. If they are not you should swing the ships compass.
	The ST30 Compass has not been aligned to a known transit bearing.	Perform the heading alignment procedure described in the calibration chapter.
No exchange of heading information between SeaTalk instruments.	SeaTalk cabling problem.	Make sure that the SeaTalk cables are plugged in correctly.

5.2 Maintenance

Certain atmospheric conditions may cause condensation to form on the display head window. This will not harm the instrument and can be easily cleared by switching the lights on to level 3 (L3).

Chemical and abrasive materials must not be used to clean the compass instrument; if it is dirty, clean it with a soft, damp cloth.

Examine all cables for chafing or damage to the outer shield and, where necessary, replace with genuine Autohelm cables and resecure.

Important note...

Only genuine Autohelm cables and spare parts must be used.

CAUTION:

Cables that cannot be replaced by simply plugging them into the appropriate equipment must be replaced by authorised Autohelm service engineers.

Chapter 6: Specification

Dimensions:	110w x 88h x 42d mm (4.3w x 3.4h x 1.6d in)
Power supply:	10 to 16.5V (12V nominal)
Current consumption:	45ma (normal) 90ma (Illumination on)
Operating temperature range:	0 to 70°C
Illumination:	3 selectable levels
Repeater capability:	Software programmable

Autohelm[®]

A **Raytheon** Company

Raytheon Marine Europe, Anchorage Park, Portsmouth
PO3 5TD, England
Telephone (01705) 693611. Fax (01705) 694642

Autohelm[®]

A **Raytheon** Company

Raytheon Marine Europe, Anchorage Park, Portsmouth
PO3 5TD, England
Telephone (01705) 693611. Fax (01705) 694642