

Raymarine®

INSTRUMENTS



ST40 INSTRUMENTS



ST40 INSTRUMENTS



Depth



Compass



Wind

Compact yet powerful, ST40 instruments feature extra large characters and razor sharp displays for outstanding visibility in all light conditions. Fully compatible with Raymarine SeaTalk® networking ST40 integrates seamlessly with Raymarine autopilots and multifunction navigation displays.

ST40 BIDATA



ST40 Bidata offers all the features of the ST40 speed and ST40 depth units in a single display. Available as a system with transducers or as a repeater display. Display features: 200Khz frequency, digital depth display of minimum depth, shallow and deep anchor alarms. Current, max and average speed display. Log, trip and sea water temperature indicator.

ST40 WIND



ST40 Wind instrument features wind speed and direction in both apparent and true. Wind angle can be locked manually or automatically. Display features: Deviation and course-to-steer to achieve locked wind angle. System supplied with rotavecta type wind transducer.



ST40 SPEED



The ST40 Speed instrument is available as a system with a transducer or as a repeater display. Display features: current, max and average speed in either knots (kts), miles per hour, (mph) or kilometers per hour (kph). Log and trip, and sea water temperature indicator.

ST40 DEPTH



The ST40 Depth instrument is available as a system with a transducer or as a repeater display. Display features: 200Khz frequency, digital depth display of minimum depth, shallow and deep anchor alarms. Depth can be displayed in feet (ft), meters (m) or fathoms (fa).

ST40 COMPASS



The ST40 compass instrument is available as a system with a compass transducer or as a repeater display for Raymarine autopilot systems. Display features: Analog compass display with true or magnetic mode.

ST60 PLUS INSTRUMENTS



ST60 PLUS INSTRUMENTS

ST60 Plus instruments combine maximum performance and versatility with bold, easy-to-read displays that set the standard for instrument systems. Based on the award winning ST60 instruments, ST60 Plus feature a new bezel design that compliments Raymarine's multifunction navigation displays. SeaTalk networking enables each instrument to receive 12 volt power and data from a single easy-to-install cable. Plug and play compatibility with Raymarine Autopilots and Multifunction Displays.



ST60 Plus with optional low profile mounting bezel

SPEED

The ST60 Plus speed provides accurate speed through water. Calibration is easy using SOG data from SeaTalk (GPS required). Available as a system with transducer or as a repeater display. Display features: Speed (0 – 60 in kts, mph or kph), max/average speed, cumulative log, trip log with reset, 1/100 knot resolution, sea temp, stop watch/lap time, 10 and 5 minute race start timer, and VMG (Velocity Made Good).



DEPTH

The ST60 Plus delivers reliable depth performance and accuracy. Available as a system with 200 KHz transducer or as a repeater display. Display features: Depth performance from 2.6' to 600' (0.8 – 180 m), maximum and minimum depth display, depth trend indicator, adjustable display response, transducer, keel or waterline offset.



WIND

The ST60 Plus wind display and systems offer reliable and accurate performance. ST60 Plus Wind offers a choice of vane or rotavecta wind transducers. Add the ST60 Plus Close Hauled repeater for precise wind measurements between 20° and 60°. Display features: Apparent wind speed and direction, true wind speed and direction (relative), max wind speed, max wind speed alarm, beaufort scale, adjustable display and pointer response, and heading on opposite tack



*Visit www.raymarine.com for a complete list of compatible NMEA 0183 sentences

GRAPHIC

A versatile repeater of SeaTalk data from compatible Raymarine instruments, autopilots, GPS, and multifunction displays. The ST60 Graphic is also NMEA 0183 compatible* for integration with other brands of marine electronics. Display features: Easy-to-use chapter and page control, depth, speed, SOG, sea temp, VMG, log and trip, true and apparent wind speed & direction (relative), beaufort scale, cardinal point, GPS Lat/Lon, COG, cross track error, bearing to waypoint/ distance to waypoint, pilot rudder angle, heading, autopilot status indicator, battery voltage/battery and voltage alarm.



TRIDATA

The versatile Tridata combines the functions of the ST60 Plus Speed and Depth instruments into a single display. Choose a Tridata system with transducers or a Tridata repeater display. Display features: Depth performance: 2.6' – 600' (0.8 – 180 m), max and min depth with trend indicator, transducer keel or waterline offset, speed with max/average display with 1/100 knot resolution, cumulative log, trip log with reset, sea temperature, stopwatch/lap timer, VMG (Velocity Made Good), SOG (requires data on SeaTalk).



COMPASS AND RUDDER

Compass and rudder displays are available as systems with transducers or as repeaters for Raymarine autopilot systems. The Compass display can also repeat GPS course over ground (COG) data from SeaTalk.

ST70 COLOR MULTIFUNCTION INSTRUMENTS



ST70 COLOR MULTIFUNCTION INSTRUMENTS

ST70 multifunction instruments offer a brand new way of visualizing instrumentation. Featuring a graphical user interface and high resolution color displays, ST70 provides unmatched versatility and ease of use. Designed for simple setup and extensive customization, ST70 delivers an array of intuitive digital, graphical and historical display options.

ST70 APPLICATIONS

The ideal companion instrument system for Raymarine MFDs, creating a full color helm solution



- Choose multiple ST70 instruments and transducers for a full featured, information rich instrument system
- Utilize ST70 as a navigation data repeater with a Raymarine multifunction display

TECH TIP: ST60 PLUS INTEGRATION

- Add color to your ST60 instrument system with an ST70 multifunction instrument
- Each ST70 instrument is supplied with a first generation SeaTalk adapter cable for plug and play connectivity with ST60/ST60 Plus instruments
- ST70 intelligently converts first generation SeaTalk data to SeaTalk^{ng}



ST70 FEATURES INCLUDE:

- 3.5" Sunlight viewable display
- Eight user defined data pages with 16 screen layout options for each data page
- Easy-to-use menu and icon driven interface
- Fast SeaTalk^{ng} next generation data bus interface for creating an ST70 instrument network
- NMEA2000 compatible for engine instrument integration
- Simple start up wizard configures every ST70 display on the SeaTalk^{ng} data bus
- Combine with SeaTalk^{ng} transducers for depth, speed and wind data
- Compatible with Raymarine SeaTalk and SeaTalk2 instrument systems as well as Raymarine autopilots and multifunction displays



Intuitive graphical displays for visualizing data



Customize the display with analog, digital, bar graphs and historical data displays



GPS and Waypoint Navigation display



Engine instrumentation using NMEA2000

ST70 PLUS INSTRUMENT & AUTOPILOT SYSTEM



ST70 PLUS INSTRUMENT & AUTOPILOT SYSTEM

The ST70 Plus system is an innovative instrumentation and autopilot display and control system engineered for premium power and sailing yachts. ST70 Plus is the perfect partner for Raymarine E-Series and G-Series navigation systems. The ultra bright 6.5" color display is ideal for installations where information is viewed at a distance. An ergonomic remote instrument keypad provides complete control of the intuitive menu and icon user interface, plus multiple ST70 Plus displays can be controlled from a single instrument keypad. ST70 Plus is fully customizable with high quality graphics, multiple color palettes and 17 unique screen layout options. Combine an ST70 Plus display with either the Sail or Power pilot keypad and enjoy full function autopilot control of any SmartPilot X-Series autopilot system.

KEY FEATURES

- 6.5" Ultra bright sunlight viewable display
- Superior visibility with high quality graphics and a wide viewing angle
- Night mode and inverse text mode enhance visibility at night or from a distance
- Create a system with SeaTalk^{ng} sensors for wind, speed, depth and NMEA2000 compatible engine systems
- User defined instrument pages
- 17 screen layout options with analog, digital, and historical displays
- Configure as either an instrument or autopilot display





INSTRUMENT KEYPAD

The instrument keypad controls all the instrument functions via a series of push buttons and a rotary 'Unicontrol' interface.



SAIL PILOT KEYPAD

Designed for sail boats, the sail pilot keypad consists of dedicated buttons to engage and disengage the autopilot, perform a dodge maneuver and track to a waypoint. Course adjustment and auto tack functions are made using the port and starboard -1, +1, -10 and +10 keys.



POWER PILOT KEYPAD

The power pilot keypad is designed specifically for powerboats. Dedicated buttons are used to engage and disengage the pilot and the rotary control provides simple course changes.



WIRELESS



WIRELESS SMARTCONTROLLER

Take control of your Raymarine SeaTalk network with the powerful SmartController wireless handheld remote. Access instrument data from ST40, and ST60 Plus in the palm of your hand. Plus SmartController is a full function autopilot remote control. The bright display and ergonomic keypad offer straightforward operation with access to up to eight user defined SeaTalk instrument data pages.



SmartController Ordering Information	
Part #	Description
E15023	SmartController with base station

ST40 NETWORK DIAGRAM

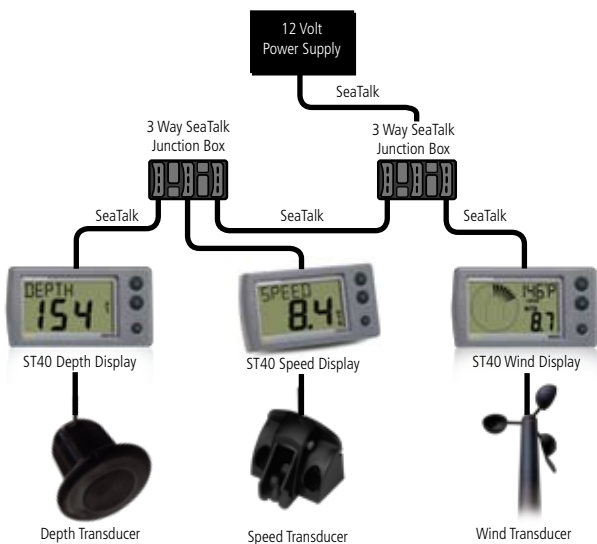

Typical ST40 Depth, Speed and Wind System

ST40 ORDERING INFORMATION

Part #	Description
E22037	ST40 Speed Display
E22038	ST40 Depth Display
E22041	ST40 Wind Display
E22039	ST40 Bidata Display
E22042	ST40 Compass Display

ST40 Systems

E22047	ST40 Wind System
E22045	ST40 Bidata System (Thru Hull)
E22054	ST40 Bidata System (Transom Mount)
E22053	ST40 Depth System (Transom Mount)
E22044	ST40 Depth System (Thru Hull)
E22052	ST40 Speed System (Transom Mount)
E22043	ST40 Speed System (Thru Hull)
E22048	ST40 Compass System



ST60 PLUS NETWORK DIAGRAM

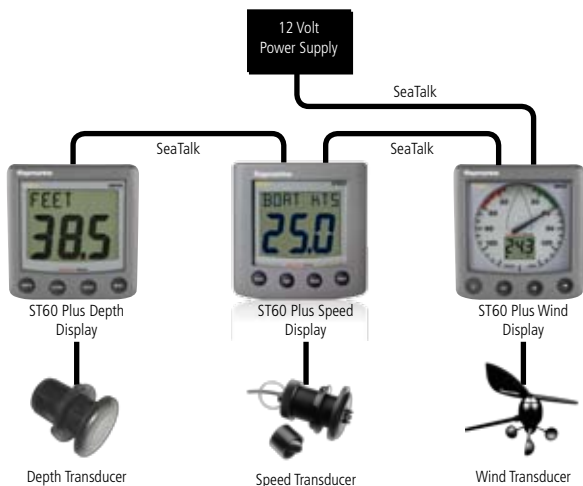

Typical ST60 Plus Depth, Speed and Wind System

ST60 PLUS ORDERING INFORMATION

Part #	Description
A22004-P	ST60 Plus Tridata Display
A22013-P	ST60 Plus Tridata System
A22002-P	ST60 Plus Depth Display
A22010-P	ST60 Plus Depth System
A22001-P	ST60 Plus Speed Display
A22009-P	ST60 Plus Speed System
A22005-P	ST60 Plus Wind Display (Analog)
A22011-P	ST60 Plus Wind System Analog Rotavecta
A22012-P	ST60 Plus Wind System Analog Vane
E22049-P	ST60 Plus Clubhouse Wind Display
A22016-P	ST60 Plus Clubhouse Wind Analog System
E22075-P	ST60 Plus Graphic Display
A22006-P	ST60 Plus CH/VMG Display
A22017-P	ST60 Plus Tridata Repeater
A22007-P	ST60 Plus Compass Display
A22014-P	ST60 Plus Compass System
A22008-P	ST60 Plus Rudder Angle Indicator Display
A22015-P	ST60 Plus Rudder Angle Indicator System
T22050-P	ST60 Plus Tridata w/Speed & Retractable Depth Transducer
T22052-P	ST60 Plus Wind System Analog Vane w/50M Cable
A25003-P	ST60 Plus Flush Mount Kit
E25009	ST60 Plus Bracket Mount Kit

ST70 NETWORK DIAGRAM

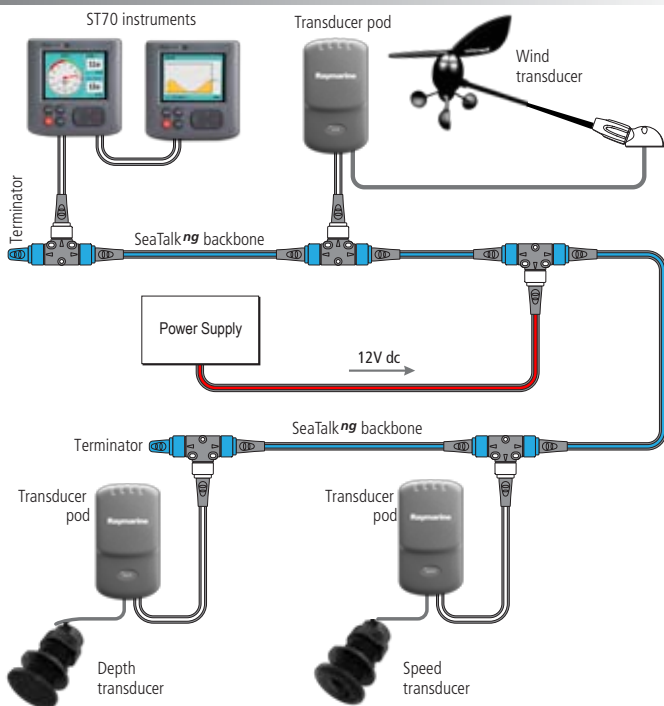

ST70 ORDERING INFORMATION

PART #	DESCRIPTION
E22105	ST70 3.5" Color Instrument Display
E22106	ST70 Depth Transducer Pod
E22107	ST70 Speed Transducer Pod
E22108	ST70 Wind Transducer Pod
A22111	Smart Depth, Speed and Temperature transducer
A22112	Smart Depth and Temperature transducer with 12 degree tilted element depth sensor



ST70 PLUS NETWORK DIAGRAM

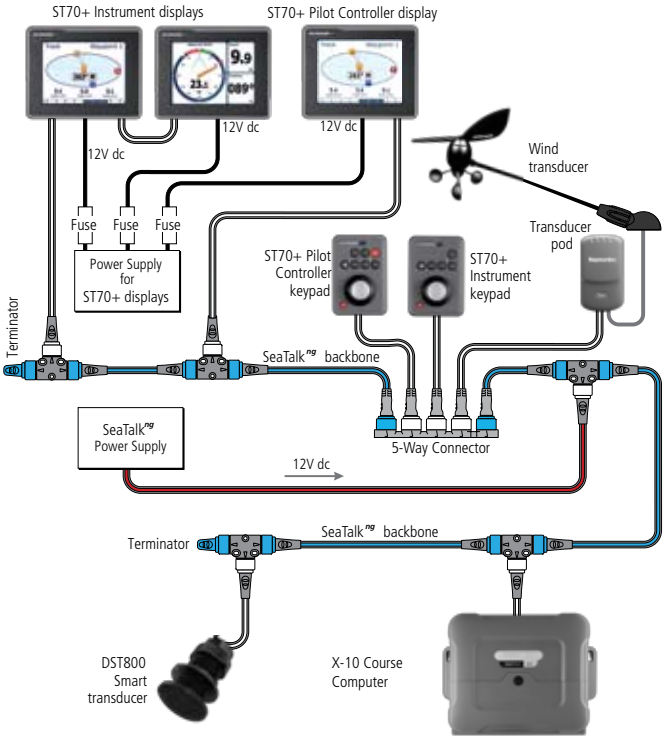

ST70 PLUS ORDERING INFORMATION

PART #	DESCRIPTION
E22115	ST70 Plus Display
E22116	ST70 Plus Instrument Keypad
E22117	ST70 Plus Sail Key Pad
E22118	ST70 Plus Power Key Pad
E22119	Analog Close Hauled Wind/VMG repeater
E22121	Analog Compass repeater
E22122	Analog Rudder Reference indicator
E22123	Analog Wind repeater

SEATALK^{ng} NEXT GENERATION DATA BUS

A fast CAN based network, SeaTalk^{ng} enables the simple interconnection of multiple ST70 instruments, transducers and NMEA2000 compatible devices. Small diameter cables and color coded connectors make SeaTalk^{ng} networks easy and straightforward to install. In addition to networking, ST70 displays and transducer pods receive power from the SeaTalk^{ng} bus, eliminating the need for additional power cables and simplifying installation.

SEATALK^{ng} FEATURES INCLUDE:

- Color coded and keyed connectors for foolproof installation of backbones and spurs
- Very small diameter connectors (11.0mm) for passing through bulkheads and in areas with limited access
- Rugged and waterproof (IP67) with positive locking connectors
- Quick and easy to install (including blind and limited access conditions)
- NMEA2000 compatible using optional SeaTalk^{ng} to DeviceNet adapter cables

SEATALK^{ng} TRANSDUCER OPTIONS

SeaTalk^{ng} transducer pods for use with depth, speed and wind transducers (pods and transducers are sold individually) SmartTM transducers do not require a pod and connect directly to the SeaTalk^{ng} databus.



200 kHz Depth transducer and SeaTalk^{ng} depth pod

Speed transducer and SeaTalk^{ng} speed pod

Wind sensor and SeaTalk^{ng} wind pod



235 kHz Depth and Temperature SmartTM Transducer with 12 degree tilted element



235 kHz Depth, Temperature and Speed SmartTM Transducer

SEATALK^{ng} CABLES AND CONNECTORS

Backbone Cables	
PART #	DESCRIPTION
A06033	1 ft 3 in (400mm) Backbone Cable
A06034	3 ft 3 in (1m) Backbone Cable
A06035	9 ft 10 in (3m) Backbone Cable
A06036	16 ft 4 in (5m) Backbone Cable
A06037	65 ft 7 in (20m) Backbone Cable
A25062	Backbone kit- Comprises: Two terminators, one 65 ft 7 in (20m) backbone cable, two 16 ft 4 in (5m) Backbone cables, four T-Piece connectors, one power cable, one SeaTalk ^{ng} Reference Manual

Spur Cables	
PART #	DESCRIPTION
A06038	1 ft 3 in (400mm) Spur Cable
A06039	3 ft 3 in (1m) Spur Cable
A06040	9 ft 10 in (3m) Spur Cable
A06041	16 ft 4 in (5m) Spur Cable
A06042	1 ft 3 in (400mm) Elbow Spur Cable - For spurs in confined spaces
A06049	Power Cable- Connects SeaTalk ^{ng} 12 V dc supply
A06043	1m Stripped end spur cable - Connects products which do not have plug in connectors (e.g. transducer pods)
A06044	3m Stripped end spur cable - Connects products which do not have plug in connectors (e.g. transducer pods)

Adapters, T Pieces & Connectors	
PART #	DESCRIPTION
A06028	T Piece- Connects one spur to backbone
A06064	5-Way Connector- Connects three spurs to backbone
A06030	Backbone Extender- Connects two backbone cables
A06031	Terminator- Fitted at each end of backbone
A06032	Blanking Plug- Inserted into unused spur connector positions in 5-way connector & T Piece
A06047	SeaTalk Adapter Cable- Connects SeaTalk ^{ng} products to SeaTalk(1)
A06048	Seataalk2 Adapter Cable- Connects SeaTalk ^{ng} products to SeaTalk ²
A06045	DeviceNet Female Adapter Cable- Connects SeaTalk ^{ng} products to NMEA2000
A06046	DeviceNet Male Adapter Cable- Connects SeaTalk ^{ng} products to NMEA2000
A06061	E-Series Adapter Cable- Connects SeaTalk ^{ng} products to Raymarine E-Series Displays

SeaTalk^{ng}
Next Generation Data Bus

ST70 Plus Display

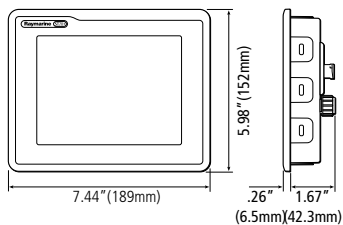

ST70 Plus Power Pilot/Instrument & ST70 Plus Sail Pilot Keypads

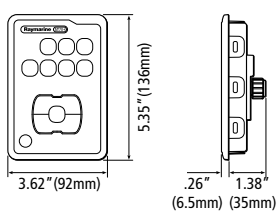

ST70 Display

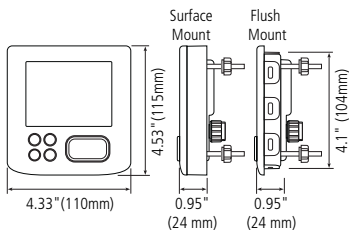

Transducer Pod

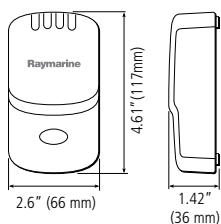

ST60 Plus Surface Mount

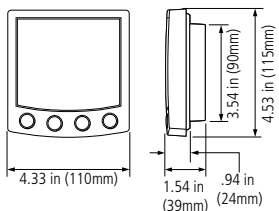

ST60 Plus Flush Mount

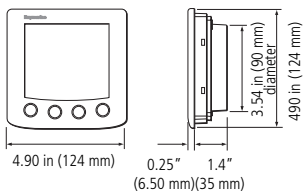

ST60 Plus Speed and Depth Transducer

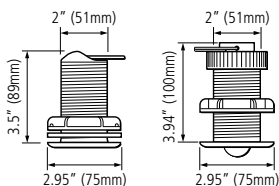

ST40 Display

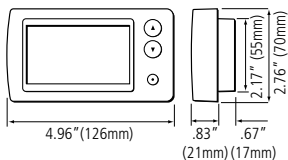

ST40 Speed and Depth Transducer

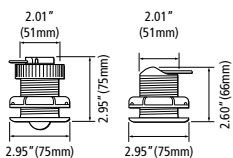

Rotavecta Wind Transducer

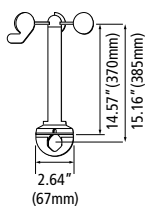

Wind Transducer

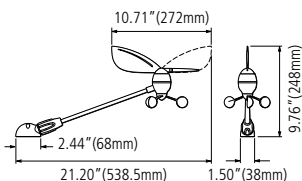

SmartController

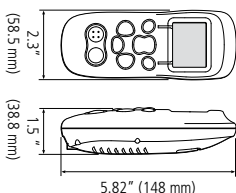

EXPLORE RAYMARINE PRODUCTS ONLINE



WWW.RAYMARINE.COM

- Extensive product information and video tutorials
- Expert technical advice and FAQs
- Connect with authorized Raymarine dealers
- Stay connected with the latest Raymarine news on our Insider Blog

Raymarine®

Raymarine Inc.
21 Manchester Street
Merrimack, NH 03054
USA
Tel: 603.881.5200
Fax: 603.864.4756
www.raymarine.com

Raymarine plc.
Marine House, 5 Harbourgate,
Southampton Road, Portsmouth,
Hampshire PO6 4BQ, UK.
Tel: +44(0)23 9269 3611
Fax: +44(0)23 9269 4642
www.raymarine.co.uk

Additional information, specifications and interactive product tours available online at www.raymarine.com

Product specifications subject to change without notice

LIT82304 - 0909

Learn about all our new products. Go to www.raymarine.com